

1.6

6	7	8
EC No.	EC Description	DR.
△	/	/

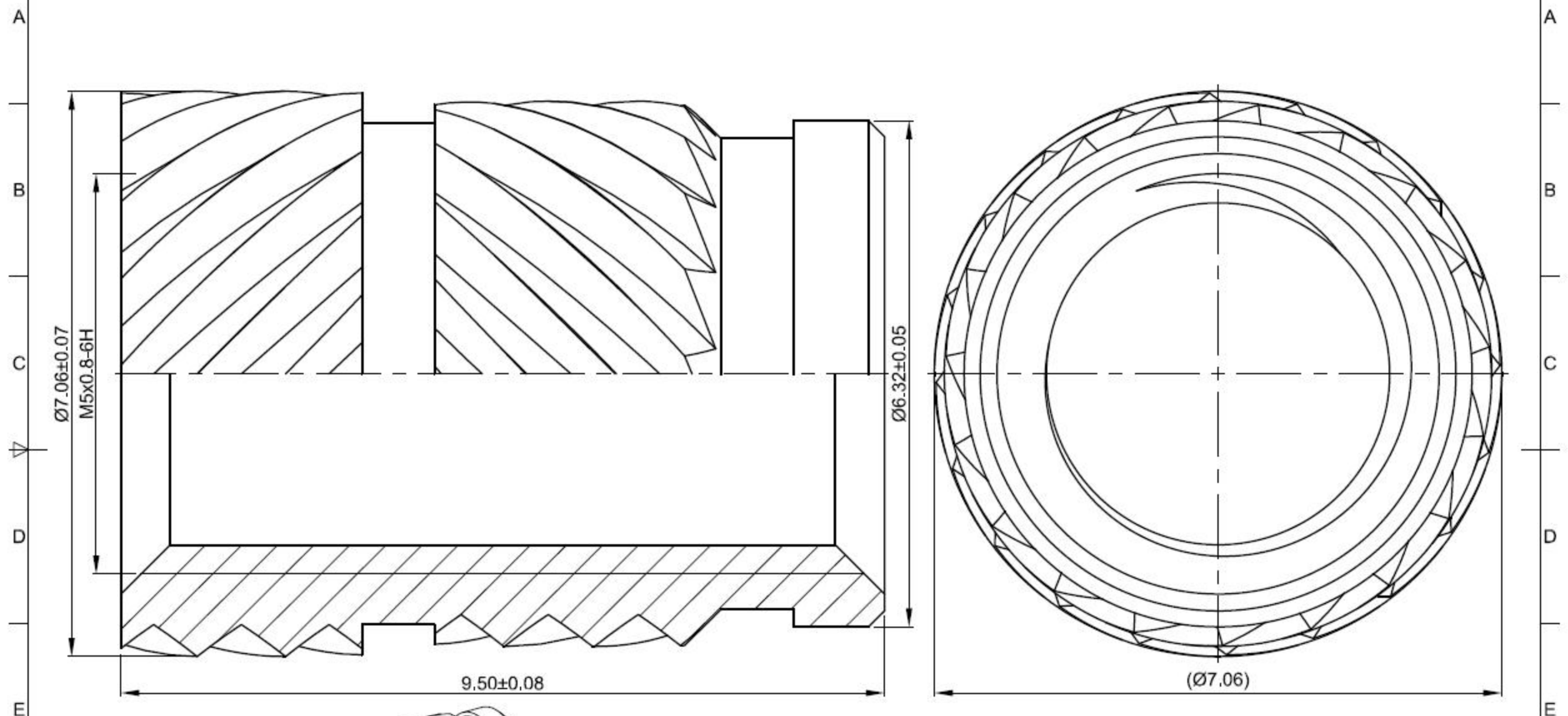

- NOTES:
- 1. Material: Brass C3604;
 - 2. Heat Treatment: None;
 - 3. Surface Treatment: Cleaning;
 - 4. Packaging: PE bag and Carton;
 - 5. Free of burrs and sharp edges;
 - 6. Thread must be checked with Go/No Go Gauge;
 - 7. Unless otherwise specified; ±0.12mm and angle ±2°.

